

PLEASE KEEP ME WITH YOUR PROOF OF PURCHASE FOR FUTURE REFERENCE.



ASSEMBLY INSTRUCTIONS

9kg Half Round Balcony Parasol Base (19004022)







ATTENTION:

1. Please read these instructions carefully before assembly
2. Aluminium is soft metal and over tightening may strip thread or break the part
3. **DO NOT** use power tools however you will require a 14mm spanner to assemble product.
4. Please allow 10 minutes for assembly.

ASSEMBLY STEPS:

1. Place parasol base (A) in desired position
2. Attach the tube (B) to the base (A) with bolt (F), washer (D) and spring washer (E)
3. Tighten bolt using a spanner, being careful not to over tighten any as this will cause the thread to become damaged
4. Place parasol pole into parasol tube, tighten Adjusting Screw (C) to secure parasol in base.

For more information regarding maintenance of your furniture please visit <http://www.hartmanuk.com>

Component's					Fixings				
Parts List	Parts Picture	Description	Q'ty	Component no.	Parts list	Parts Picture	Description	Q'ty	Part no.
A		Base	1	19004022A	E	 φ 14/ φ 11MM	Spring Washer	1	2100053
B		Tube	1	19004022B	F	 M10*65	Bolt	1	2100054
C	 M8*39MM	Adjusting Screw	1	2100051					
D	 φ 19/ φ 11MM	Washer	1	2100052					

For replacement or lost spare parts please go to <http://faq.hartmanuk.co.uk/spares/>

Should you have any queries about your furniture your first point of contact should be the retailer from whom you purchased your product.

PLEASE KEEP ME WITH YOUR PROOF OF PURCHASE FOR FUTURE REFERENCE.



ASSEMBLY INSTRUCTIONS

9kg Half Round Balcony Parasol Base

(19004022)

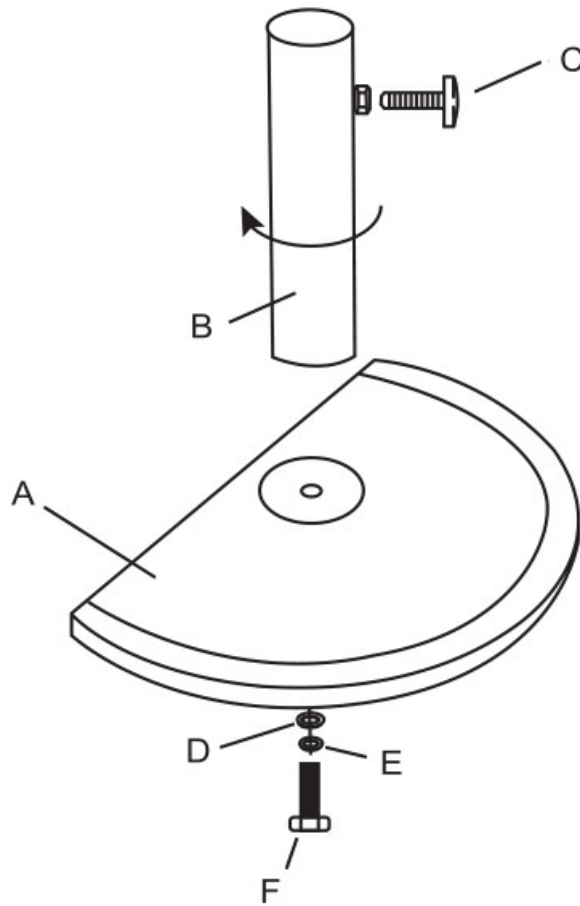

For replacement or lost spare parts please go to <http://faq.hartmanuk.co.uk/spares/>

Should you have any queries about your furniture your first point of contact should be the retailer from whom you purchased your product.