

PLEASE KEEP ME WITH YOUR PROOF OF PURCHASE FOR FUTURE REFERENCE



ASSEMBLY INSTRUCTIONS

Heritage Hanging Chair (SINGLE)

(68038145 / 68038146)

ATTENTION:













1. Please read these instructions carefully before assembly
2. Aluminium is soft metal and over tightening may strip thread or break the part
3. **DO NOT** use power tools
4. Please allow 30 minutes for assembly
5. Although assembly only requires 1 person it is advised that a second person be present to help turn the product over and into position when fully assembled

ASSEMBLY STEPS:

1. **LOOSELY** attach hanging tube (A) to the base (B) with bolts (H) & (I), big flat washers (J) and Locknut (L) using spanner (N) **DO NOT TIGHTEN BOLTS AT THIS STAGE**
2. Tighten all bolts one by one with spanner (N) being careful not to over tighten any as this will cause the thread to become damaged
3. Place Nut cap (K and M) on all visible bolts (H & I) and locknut (L)
4. Insert metal bolt (E) into the hole on top of each hanging tube
5. Screw the metal hook (G) into the thread at the top of the basket (C), then hang the basket to the pole using the chains (D) to connect the metal bolt on top of the pole and hook on the basket
6. Place the cushion (F) on the seat
7. Attach the safety cord to the basket, using the karabiner hook onto the ring at the back of the base tube – *WE NEED ILLUSTRATIONS AND IMAGES FOR THIS ADDITIONAL POINT PLEASE*

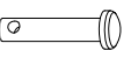
For more information regarding maintenance of your furniture please visit

http://www.hartmanuk.co.uk/after_care_videos.html

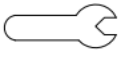
| Component's | | | | Fixings | | | | | |
|-------------|---|--------------|------|------------------------|------------|---|------------------|------|--------------------|
| Parts List | Parts Picture | Description | Q'ty | Part no | Parts list | Parts Picture | Description | Q'ty | Part no. |
| A |  | Hanging tube | 1 | 68038145A 68038146A | H |  | M8*20 bolts | 1 | 2100045 |
| B |  | Base | 1 | 68038145B 68038146B | I |  | M8*60 bolts | 1 | 1008163 |
| C |  | Basket | 1 | 68038145C 68038146C | J |  | Big Flat washers | 2 | 1061162 |
| D |  | Chain | 1 | 68038145D 68038146D | K |  | PVC Cap | 2 | 2100036 2100037 |
| E |  | Bolt | 1 | 68038145E 68038146E | L |  | Locknut | 1 | 2002178 |
| F |  | Cushion | 1 | 68038145F 68038146F | M |  | Nut cap | 1 | 2100038 2100039 |
| G |  | Metal hook | 1 | 68038145G 68038146G | N |  | Spanner | 1 | 2100046 |

For replacement or lost spare parts please go to <http://faq.hartmanuk.co.uk/spares/>

Should you have any queries about your furniture your first point of contact should be the retailer from whom you purchased your product

PLEASE KEEP ME WITH YOUR PROOF OF PURCHASE FOR FUTURE REFERENCE



ASSEMBLY INSTRUCTIONS

Heritage Hanging Chair (SINGLE) NEW 2021

(68038145 / 68038146)

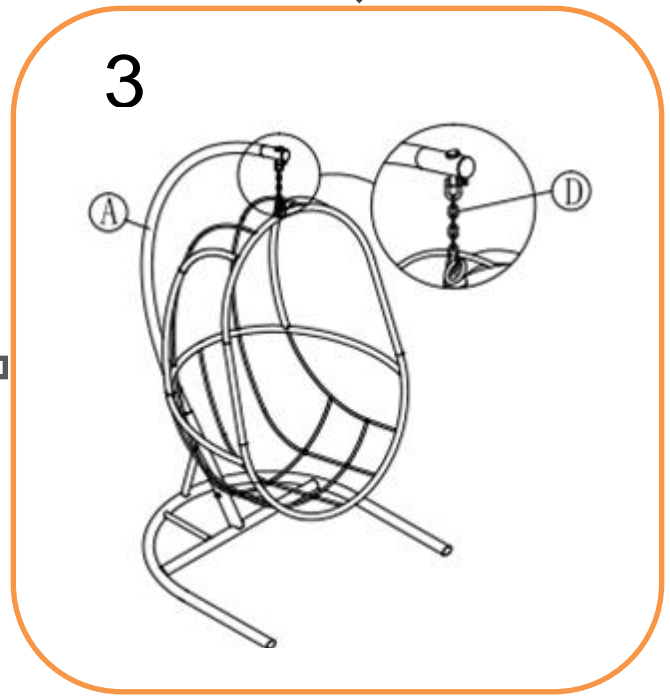
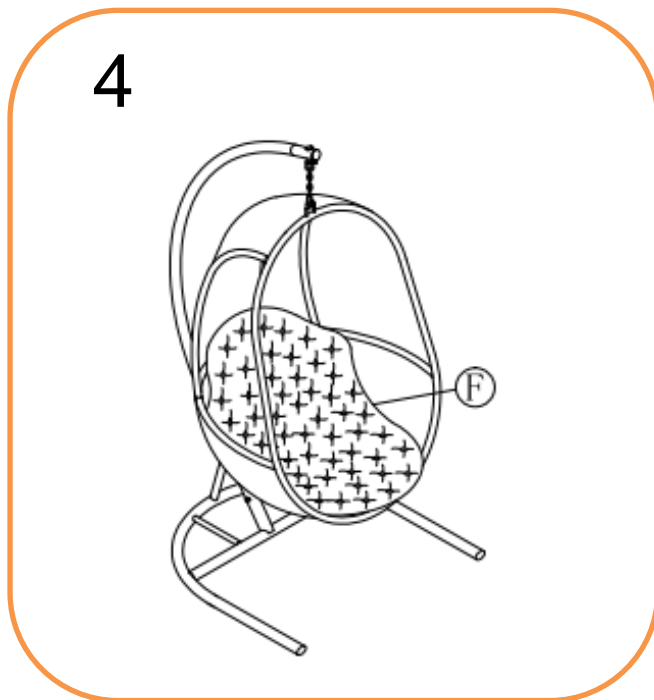
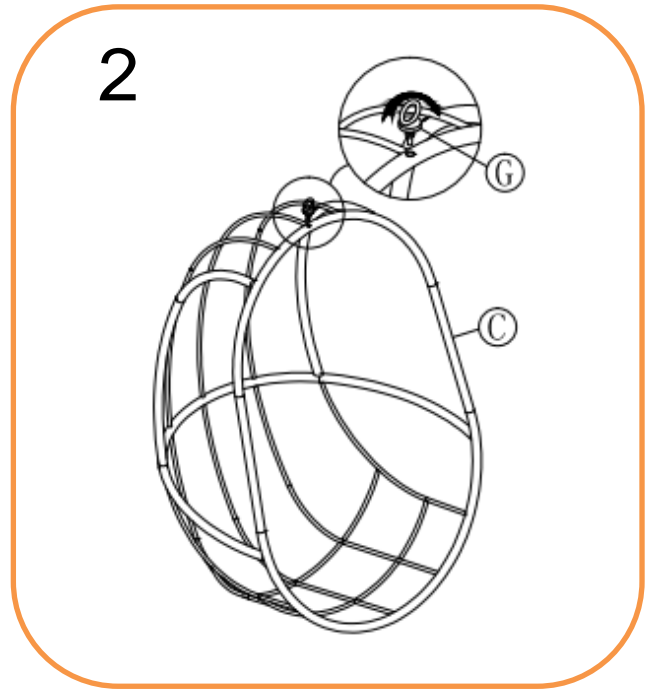
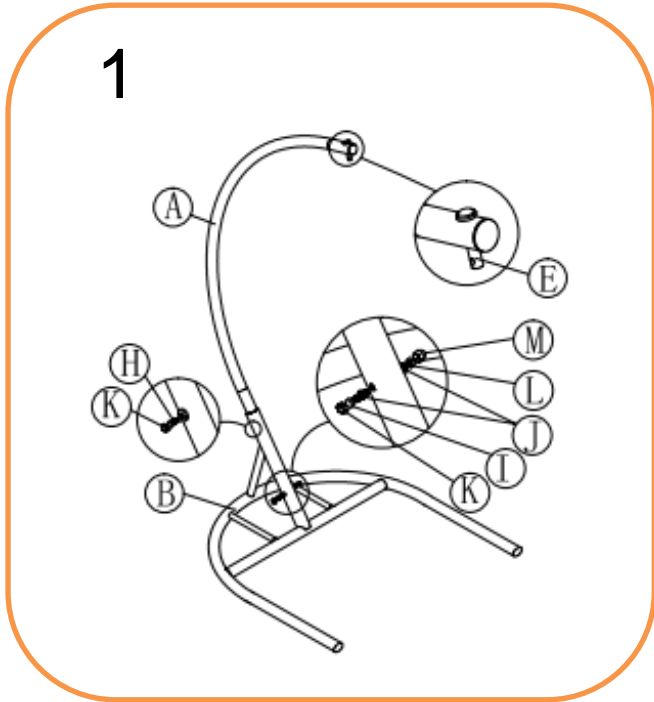

For replacement or lost spare parts please go to <http://faq.hartmanuk.co.uk/spares/>
Should you have any queries about your furniture your first point of contact should be the retailer from whom you purchased your product