

PLEASE KEEP ME WITH YOUR PROOF OF PURCHASE FOR FUTURE REFERENCE











ATTENTION:

1. Please read these instructions carefully before assembly
2. Aluminium is soft metal and over tightening may strip thread or break the part
3. **DO NOT** use power tools
4. Please allow 30 minutes for assembly
5. Although assembly only requires 1 person it is advised that a second person be present to help turn the table over and into position when fully assembled

ASSEMBLY STEPS:

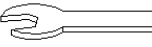
1. LOOSELY attach legs (B) to panels (C) with bolts (F) and big flat washers (G), plastic washers (L) and small lock washer (H) using spanner (J)
2. Take glass off the table (D) (in case of breakage) turn the table top (A) upside down on a soft clean surface
3. LOOSELY attach the pre-assembled leg section to the table top with bolts (E) and big flat washers (G) and small lock washer (H) using spanner (J) **DO NOT TIGHTEN THE BOLTS AT THIS STAGE**
4. Using the spanner, gradually tighten the bolts in turn. Do not over tighten any bolts as this will cause the thread to become damaged
5. Place Nut Caps (I) on all visible bolts (E and F)
6. Turn your assembled table over and position where required
7. Carefully place glass top (D) onto the table top and gently press on to suckers, then put parasol bung & cap (K) into the hole
8. Don't forget your Warranty Registration with Hartmanuk.com

For more information regarding maintenance of your furniture and to register your warranty, please visit www.hartmanuk.com

Component's				Fixings					
Parts List	Parts Picture	Description	Q'ty	Part no	Parts list	Parts Picture	Description	Q'ty	Part no.
A		Table Top	1	68104145A	G		Big Flat washers	12	1061162
B		Legs	2	68104145B	H		Small lock Washers	12	1221162
C		Panel	2	68104145C	I		Nut Cap	12	2002170
D		Glass	1	68104145D	J		Spanner	1	1020162
E		M6*20 bolts	4	2002169	K		Parasol bungs & reducers	3	2002180 2002181
F		M6*40 bolts	8	2002190	L		Plastic washers	8	

For replacement or lost spare parts please go to <http://faq.hartmanuk.co.uk/spares/>

Should you have any queries about your furniture your first point of contact should be the retailer from whom you purchased your product

PLEASE KEEP ME WITH YOUR PROOF OF PURCHASE FOR FUTURE REFERENCE

Hartman!!!

ASSEMBLY INSTRUCTIONS

Heritage 110cm Inlaid Round Table (GLASS)

(68104145)

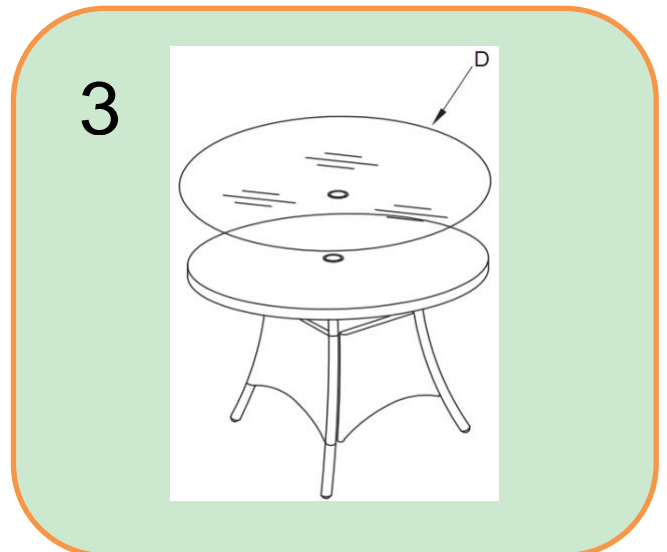
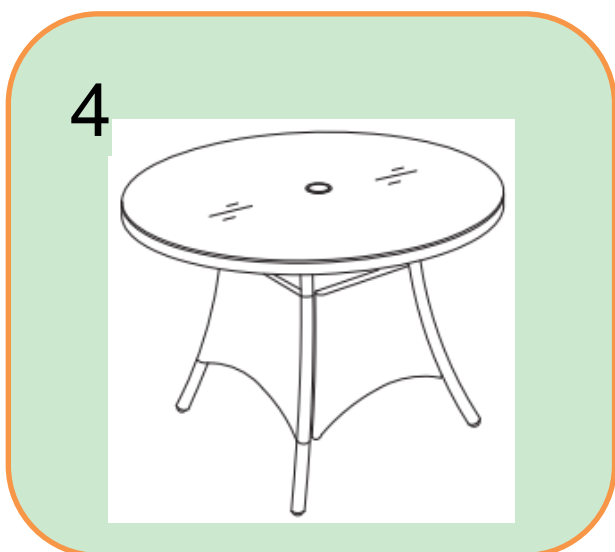
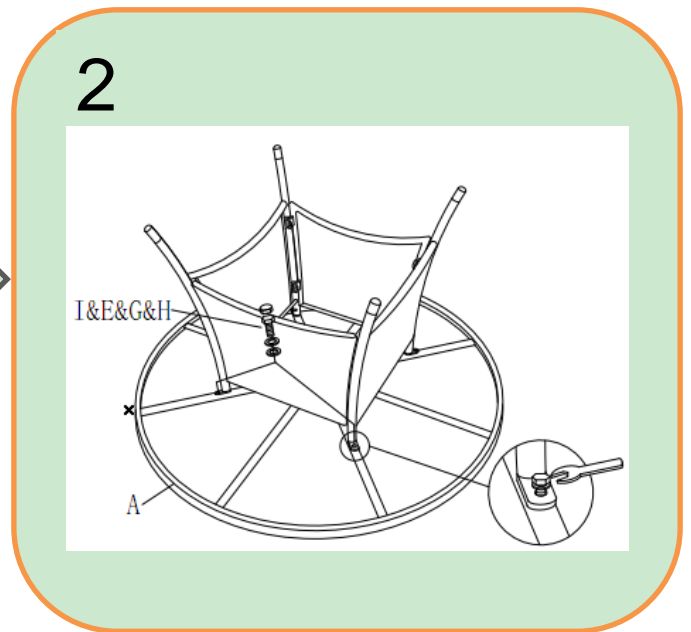
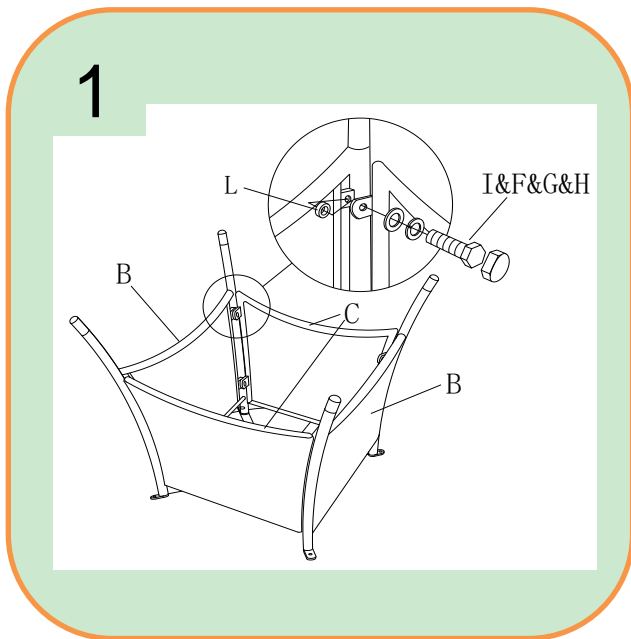

For replacement or lost spare parts please go to <http://faq.hartmanuk.co.uk/spares/>
Should you have any queries about your furniture your first point of contact should be the retailer from whom you purchased your product